

RESISTANCE

CAPACITANCE

For safety purposes, use all components with a symbol with an identical (1)

RESISTANCE
 CERAMIC
 STABILITY
 HIGH STABILITY

2.5%
 10%
 1.7%
 10%
 1.7%

10%
 1.7%
 1.7%

10%
 1.7%
 1.7%

10%
 1.7%
 1.7%

10%
 1.7%
 1.7%

10%
 1.7%
 1.7%

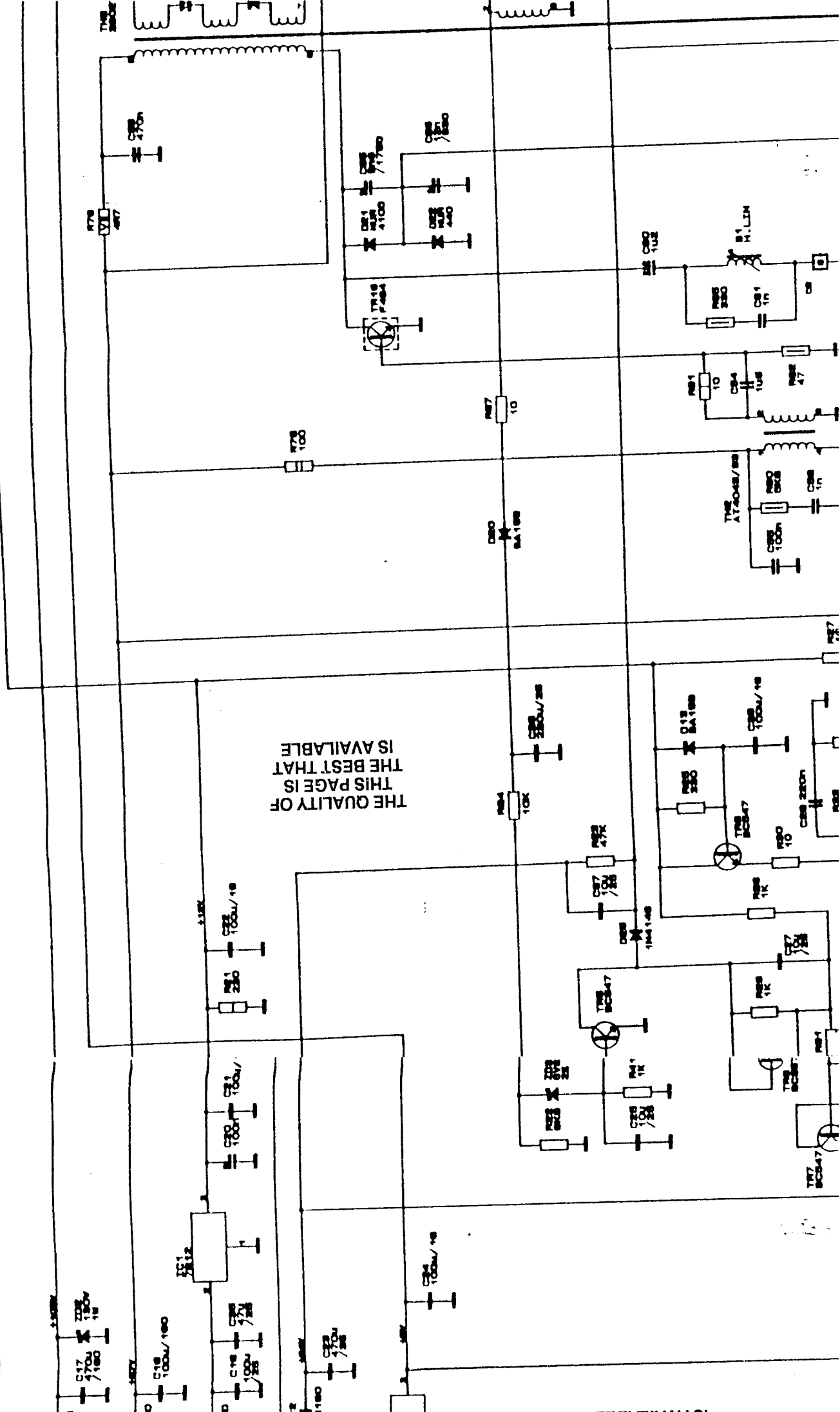

THE QUALITY OF THIS PAGE IS AVAILABLE

IS AVAILABLE

THE QUALITY OF
THIS PAGE IS
THE BEST THAT
IS AVAILABLE

RESISTORS ARE SHOWN WITH
VALUES IN OHMS UNLESS
OTHERWISE INDICATED
RESISTOR TOLERANCES ARE
UNLESS OTHERWISE SPECIFIED
RESISTOR VALUES IN OHMS
SHOULD BE INDICATED BY
A ZERO (0) IN THE
MULTIPLIER POSITION

RESISTOR SYMBOLS ARE SHOWN
UNLESS OTHERWISE SPECIFIED
RESISTOR VALUES IN OHMS
SHOULD BE INDICATED BY
A ZERO (0) IN THE
MULTIPLIER POSITION

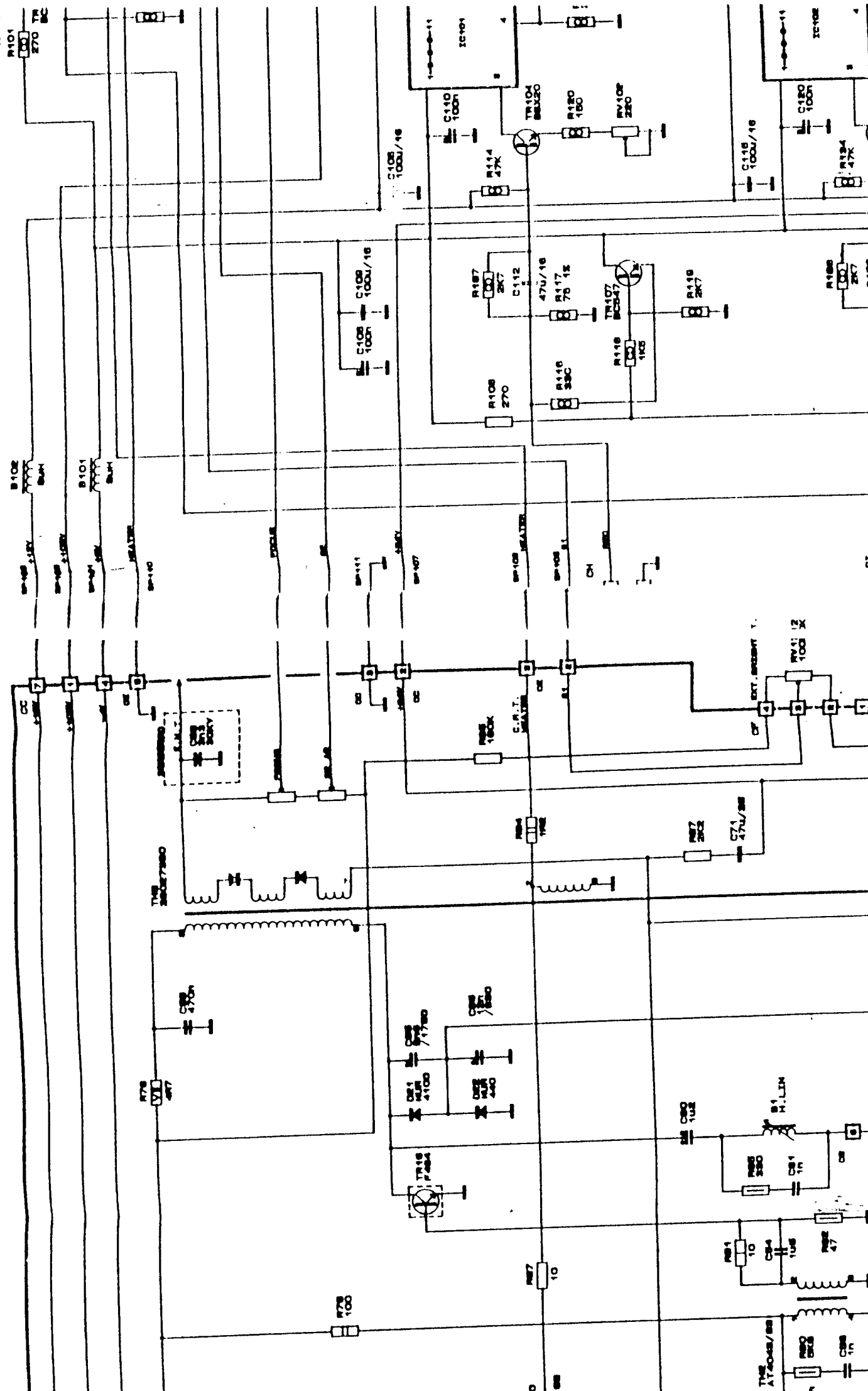

THE QUALITY OF
THIS PAGE IS
THE BEST THAT
IS AVAILABLE

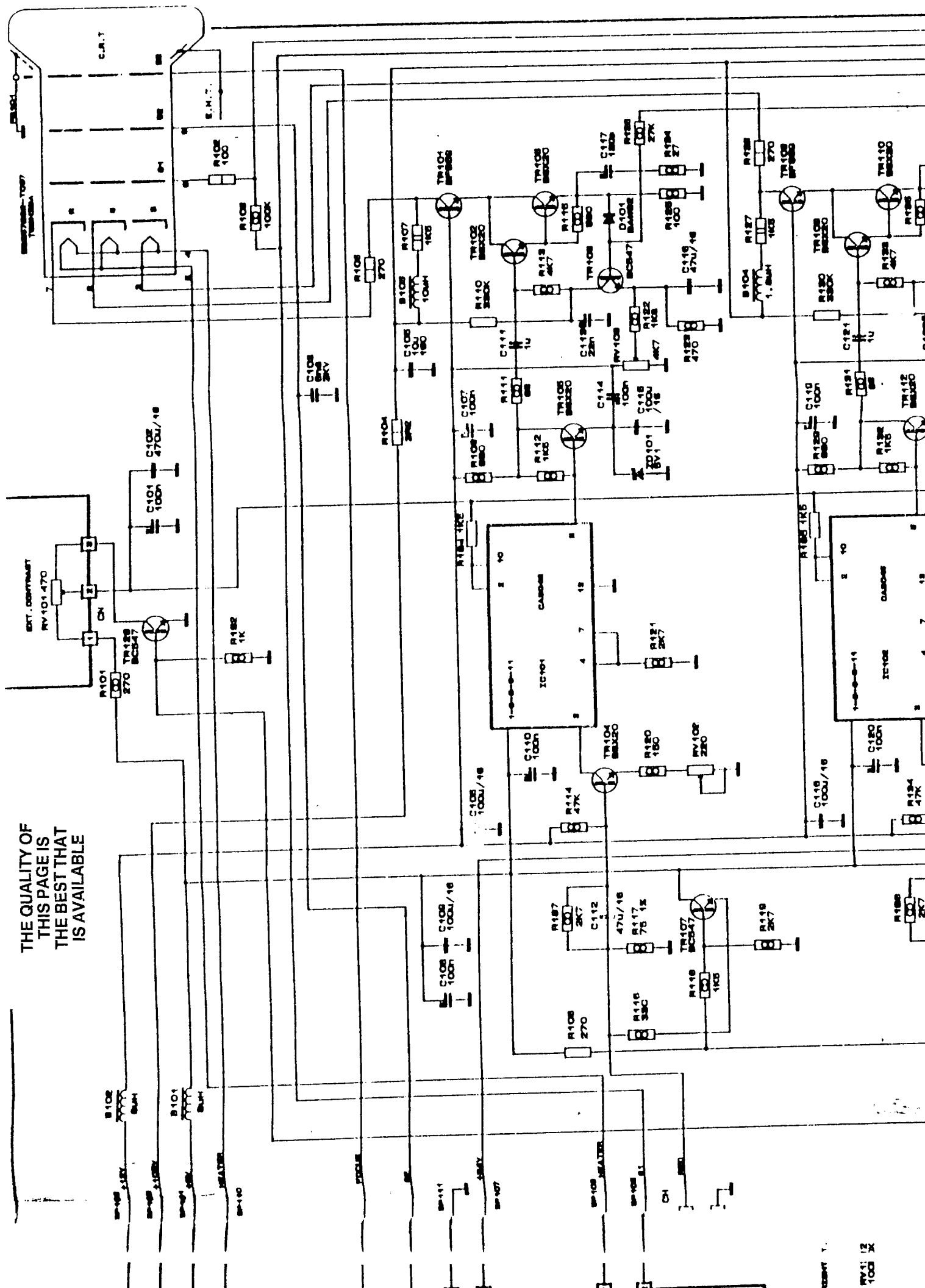

THE QUALITY OF
THIS PAGE IS
THE BEST THAT
IS AVAILABLE

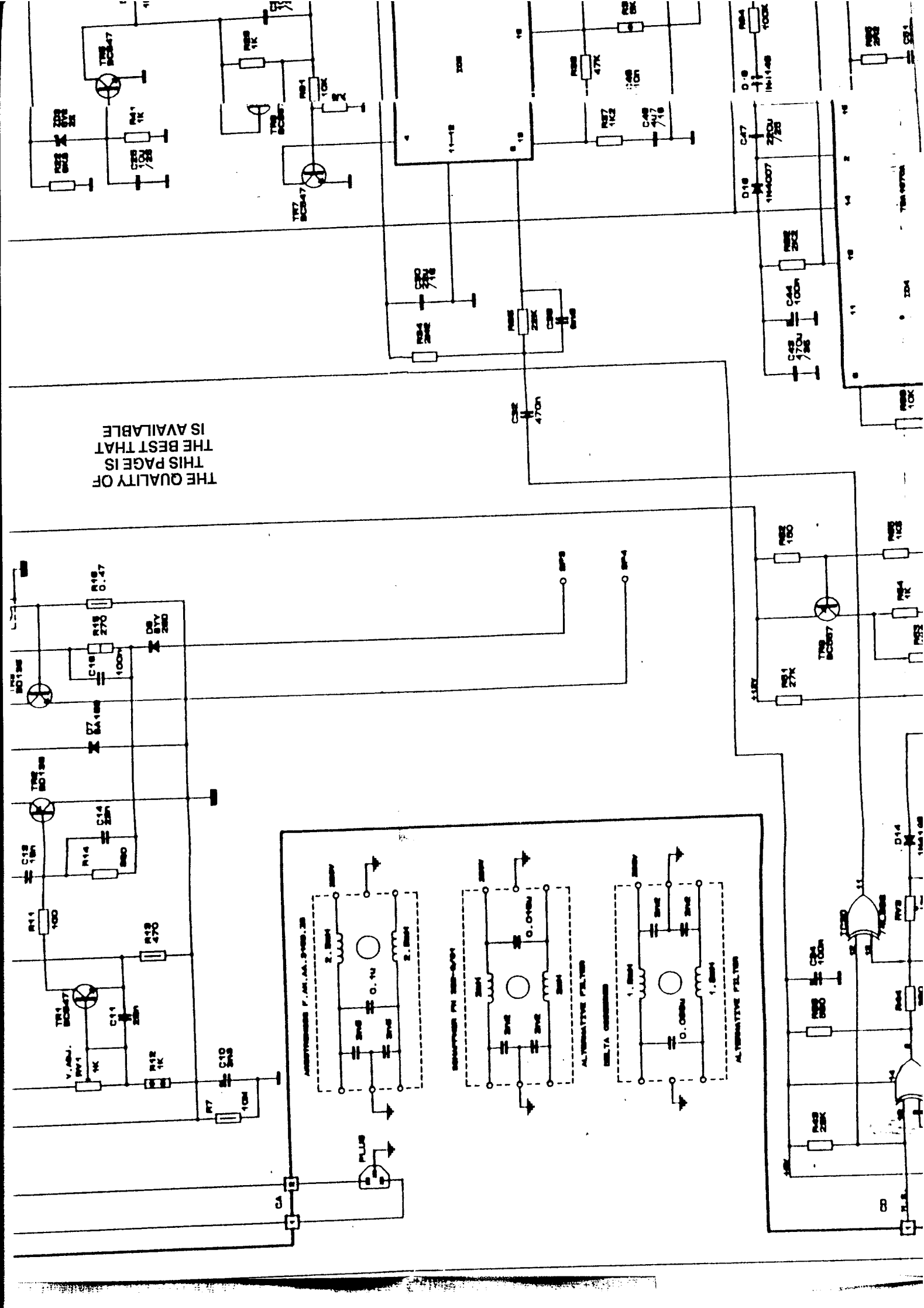

THE QUALITY OF
THIS PAGE IS
THE BEST THAT
IS AVAILABLE

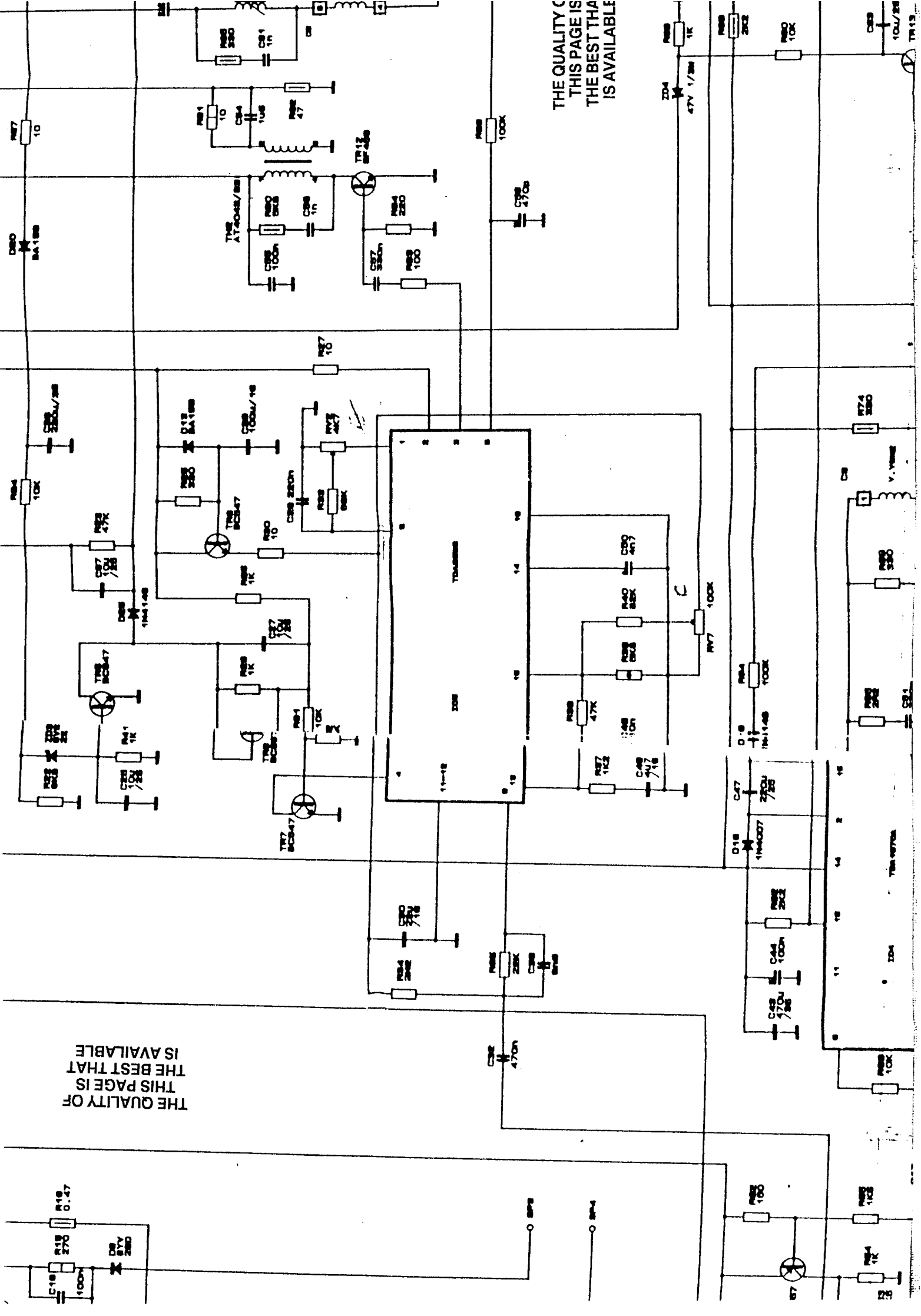

THE QUALITY OF
THIS PAGE IS
THE BEST THAT
IS AVAILABLE

THE QUALITY OF
THIS PAGE IS
THE BEST THAT
IS AVAILABLE

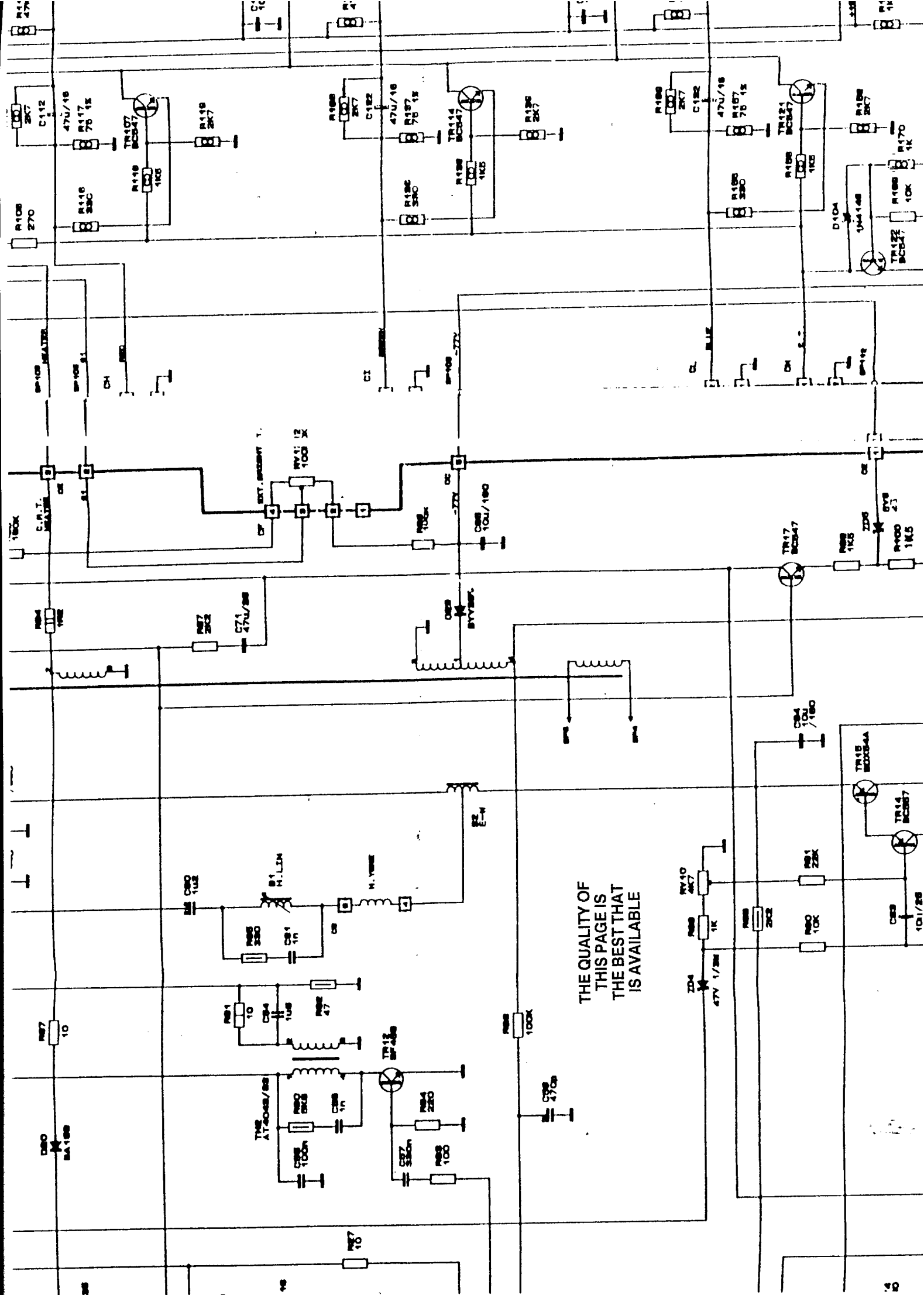

THE QUALITY OF
THIS PAGE IS
THE BEST THAT
IS AVAILABLE

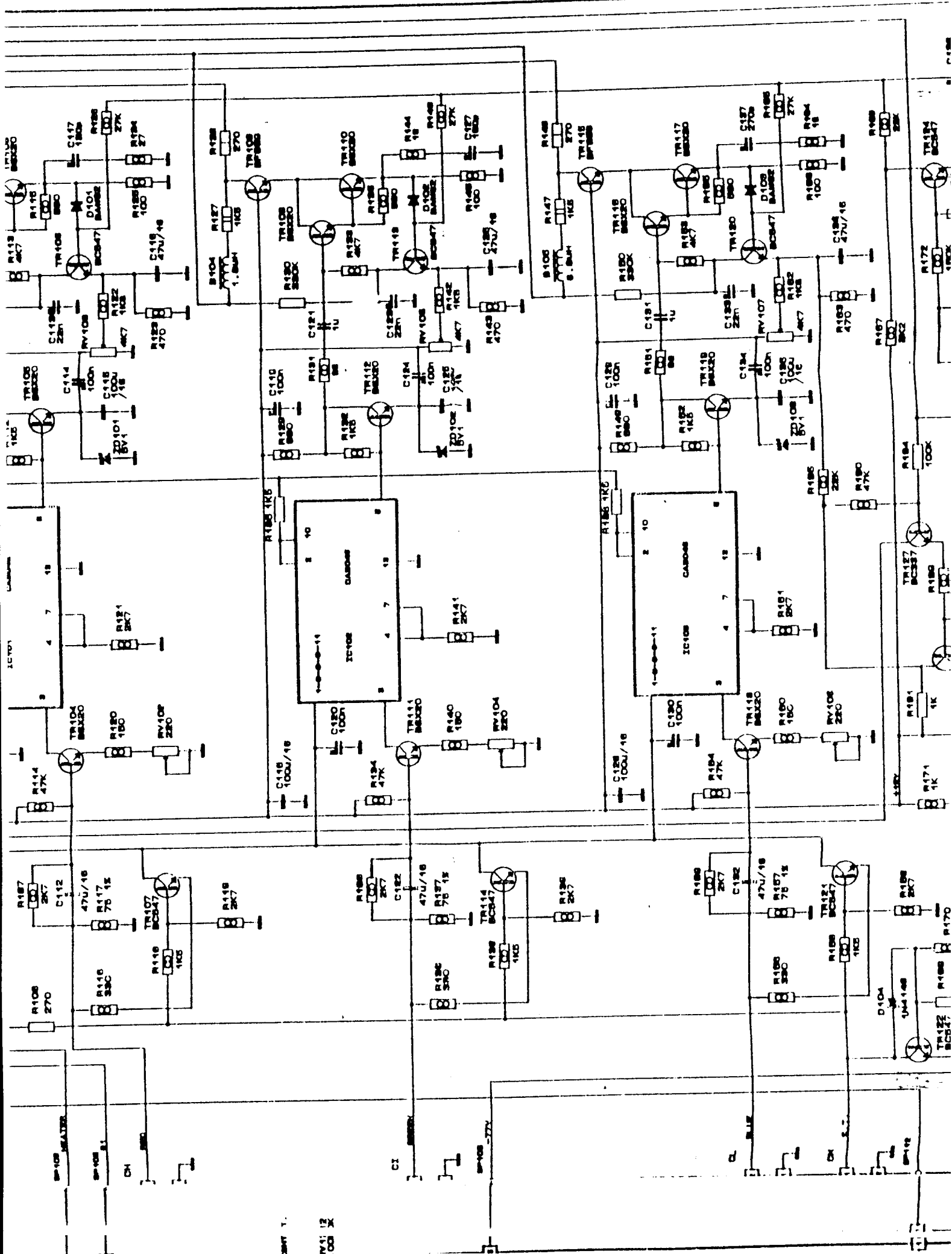

REV T.
 001 12
 002 12

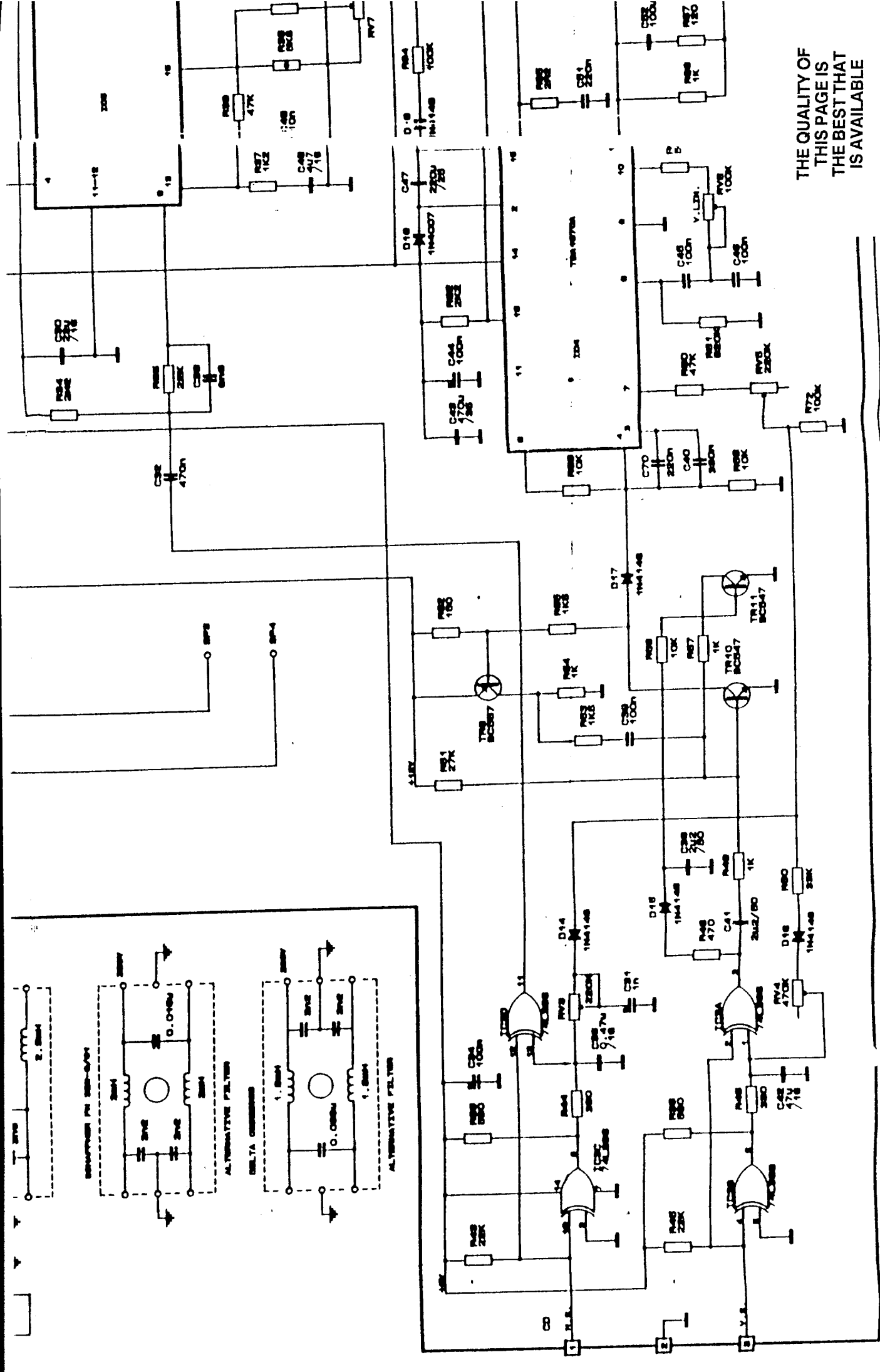

THE QUALITY OF
THIS PAGE IS
THE BEST THAT
IS AVAILABLE

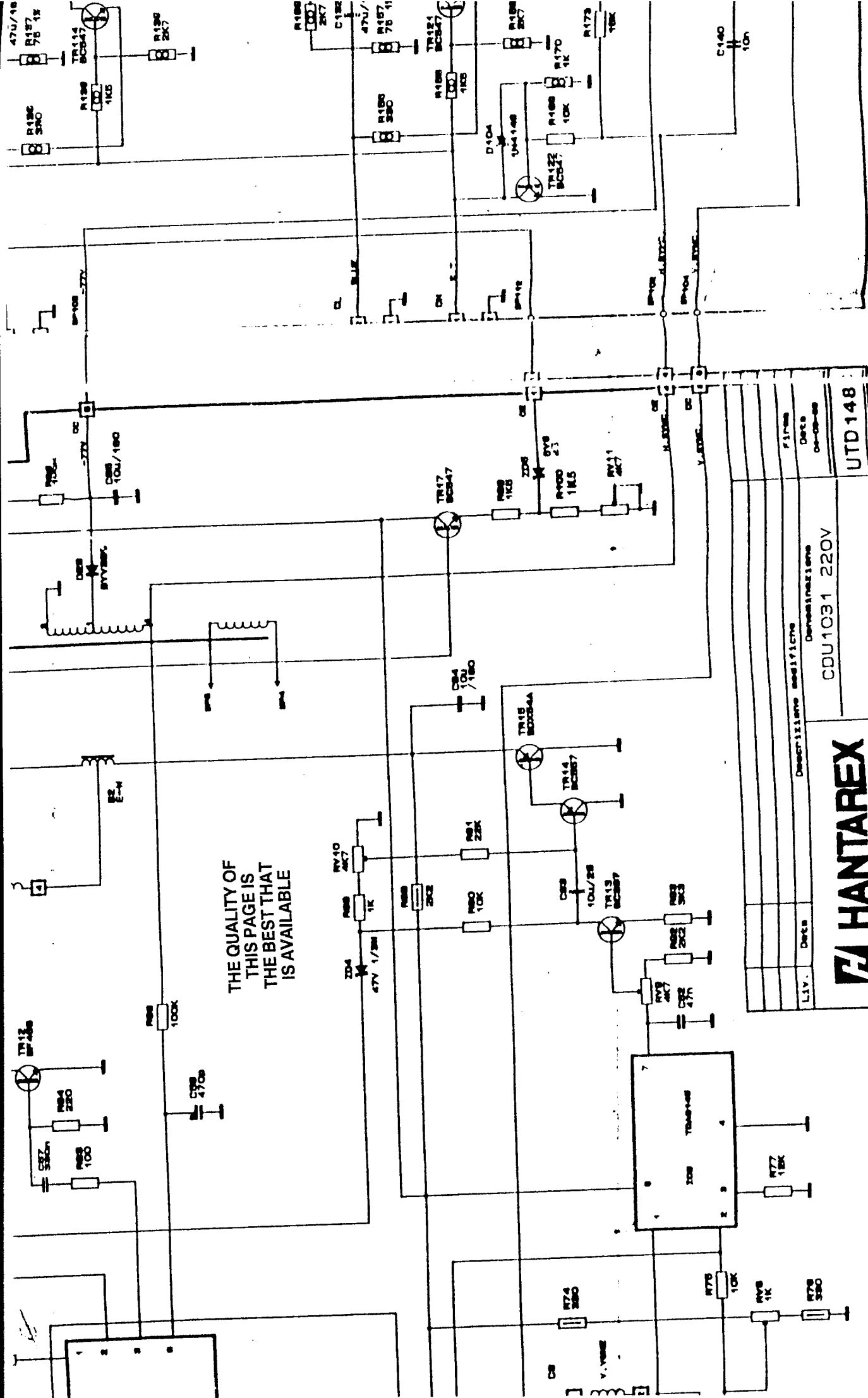

THE QUALITY OF
THIS PAGE IS
THE BEST THAT
IS AVAILABLE

Description		Date	
CDU1031 220V		01-01-68	
UTD148			



CDU1031 220V

UTD148

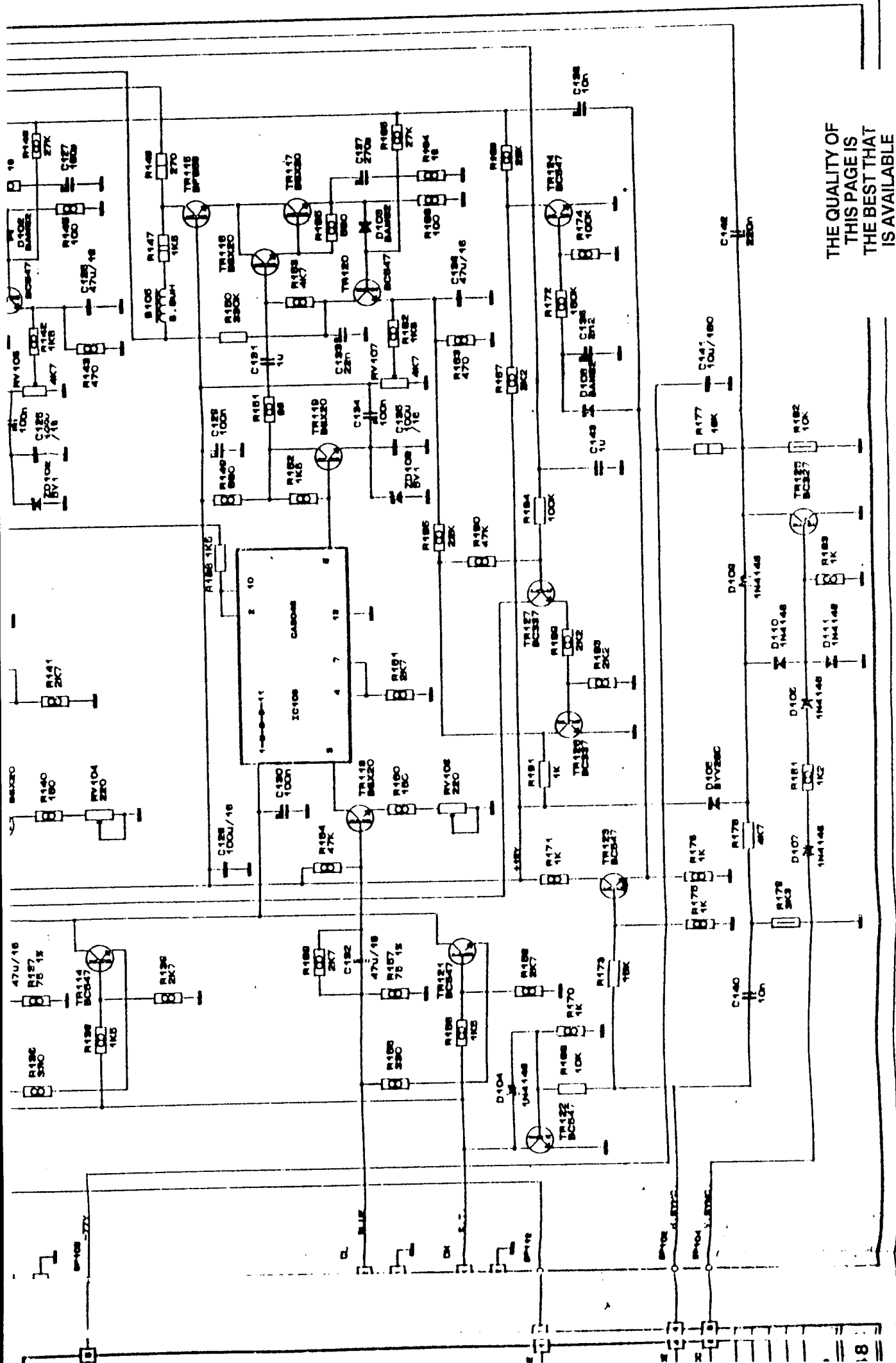

THE QUALITY OF
THIS PAGE IS
THE BEST THAT
IS AVAILABLE